

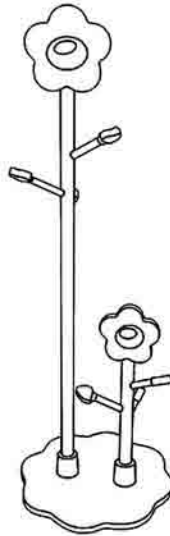

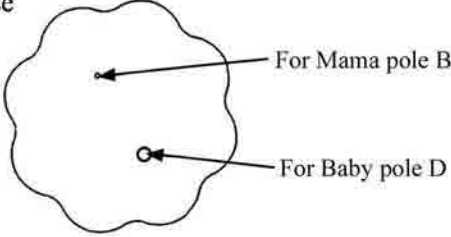

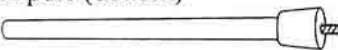

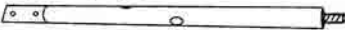

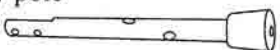
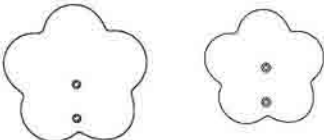
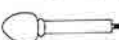

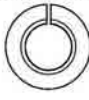
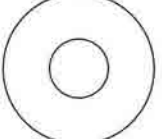
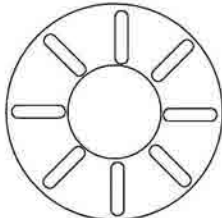

# ASSEMBLY INSTRUCTIONS

## FOR YOUR

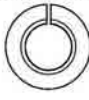
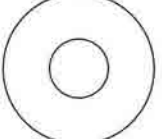
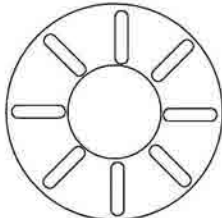
### ROCK A MY BABY CLOTHESTAND

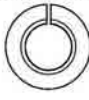
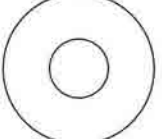
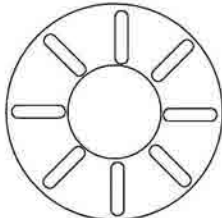

<p><b>A. Base</b></p>  <p><b>B. Mama pole (bottom)</b></p>  <p><b>C. Mama pole (top)</b></p>  <p><b>D. Baby pole</b></p>  <p><b>E. Mama Flower    F. Baby Flower</b></p>  <p><b>G. Hanger (6 pcs)</b></p> 	<p style="text-align: center;">(shown actual size)</p> <table style="width: 100%;"> <tr> <td style="width: 50%; vertical-align: top;"> <p><b>H. Screw (4 pcs)</b> Length. 1-1/16"</p>  <p><b>I. Washer (4 pcs)</b> Outer diam. 5/8"</p>  <p><b>J. Spring Washer (4 pcs)</b> Outer diam. 3/8"</p>  <p><b>K. Screw (1 pc)</b> Length. 1-1/4"</p>  </td> <td style="width: 50%; vertical-align: top;"> <p><b>L. Spring Washer (1 pc)</b> Outer diam. 1/2"</p>  <p><b>M. Washer (1 pc)</b> Outer diam. 7/8"</p>  <p><b>N. Washer (1 pc)</b> Outer diam. 1-1/4"</p>  </td> </tr> </table>	<p><b>H. Screw (4 pcs)</b> Length. 1-1/16"</p>  <p><b>I. Washer (4 pcs)</b> Outer diam. 5/8"</p>  <p><b>J. Spring Washer (4 pcs)</b> Outer diam. 3/8"</p>  <p><b>K. Screw (1 pc)</b> Length. 1-1/4"</p> 	<p><b>L. Spring Washer (1 pc)</b> Outer diam. 1/2"</p>  <p><b>M. Washer (1 pc)</b> Outer diam. 7/8"</p>  <p><b>N. Washer (1 pc)</b> Outer diam. 1-1/4"</p> 
<p><b>H. Screw (4 pcs)</b> Length. 1-1/16"</p>  <p><b>I. Washer (4 pcs)</b> Outer diam. 5/8"</p>  <p><b>J. Spring Washer (4 pcs)</b> Outer diam. 3/8"</p>  <p><b>K. Screw (1 pc)</b> Length. 1-1/4"</p> 	<p><b>L. Spring Washer (1 pc)</b> Outer diam. 1/2"</p>  <p><b>M. Washer (1 pc)</b> Outer diam. 7/8"</p>  <p><b>N. Washer (1 pc)</b> Outer diam. 1-1/4"</p> 		



**WARNING:**

Products shall be assembled by adult. Product contains sharp point, sharp edge and small parts before assembled.

Keep out of child's reach when products unassembled.

Do not hang any item weighing more than 30 pounds on any one hanger.

Fig. 1 Attach Mama pole (B, C) to Base (A) and Mama flower (E) to pole (C)

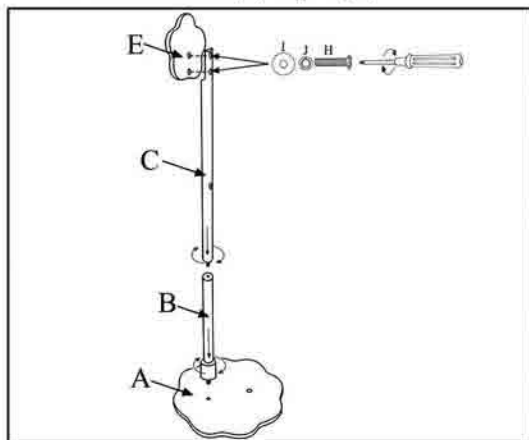

- Screw Mama pole (B) into the smaller hole on Base (A) and then screw pole (C) into pole (B) until tight.
- Align the holes of Mama flower (E) to the pre-drilled holes of pole (C).
- Put Washer (I), Spring washer (J), and Screw (H) in sequence into the pre-drilled holes and screw them in with Philips head screwdriver until secure.

Fig. 2 Attach Baby flower (F) to Baby pole (D)

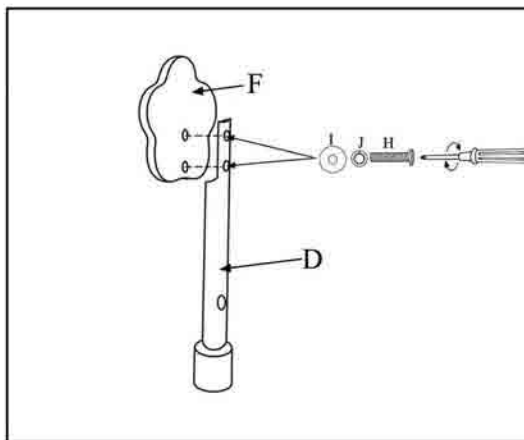

- Align the holes of Baby flower (F) to the pre-drilled holes of pole (D).
- Put Washer (I), Spring washer (J), and Screw (H) in sequence into the pre-drilled holes and screw them in with Philips head screwdriver until secure.

Fig. 3 Attach assembled Baby pole and flower (as Fig.2) to Base (A)

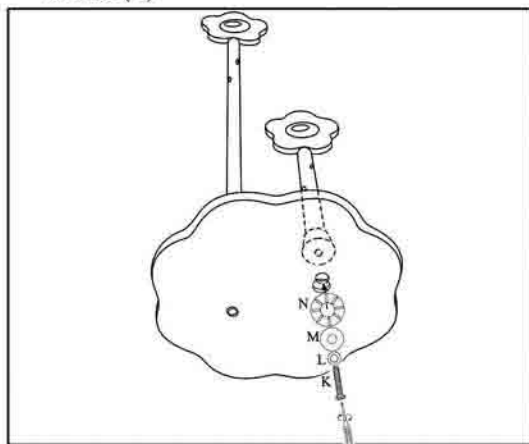

- Line up the assembled Baby flower (as Fig. 2) with assembled Mama flower (as Fig.1). Then, insert the assembled Baby pole and flower into Base (A).
- Put Washer (N), Washer (M), Spring washer (L), and Screw (K) in sequence into the pre-drilled hole on the bottom of Base (A) and screw them in with Philips head screwdriver until secure.

Fig. 4 Attach six hangers (G) to pole (C) and (D)

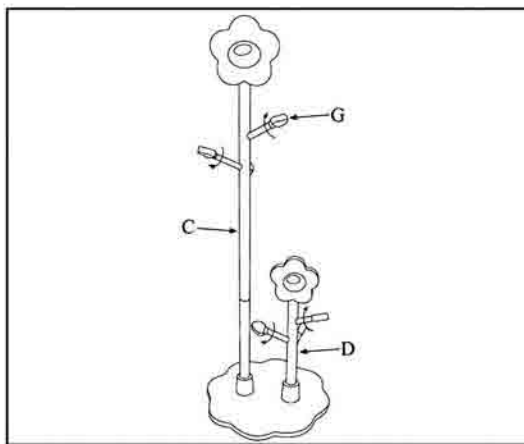

- Screw 3 hangers (G) into pole (C) until tight
- Screw 3 hangers (G) into pole (D) until tight

Finally, please check that all parts are tightened securely but **do not overtighten**.

Your Rock A My Baby Clothestand should now be ready to use. Enjoy!

Please visit our website and discover all our other innovative and fun products for kids at:

[www.levelsofdiscovery.com](http://www.levelsofdiscovery.com)

Rock A My Baby Clothestand  
© 2004 Levels of Discovery LLC  
Roselle, Illinois 60172

Made in China  
Printed in China